

# Tecnodin **Bisagras**

Pág.

117



117



117



117



118



118



118



118



119

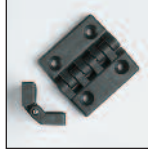

119



120



120



Pág.

121



121



121



## 470054K BISAGRA PLANA K CON INSERTOS ROSCADOS



Poliamida reforzada resistente a grasas y aceites. Eje de acero cincado y casquillos de latón.

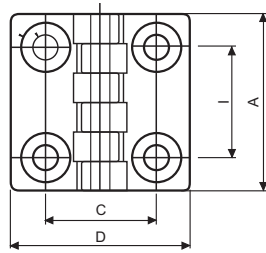

Código	A	D	I	C	H	B	d	e1	Color
47005404301	48	48	30	30	15,5	10,5	M5	7	Negro
47005406301	64	64	40	40	19	13	M6	9	Negro
47005409301	95	95	60	63	28,5	19	M8	13	Negro

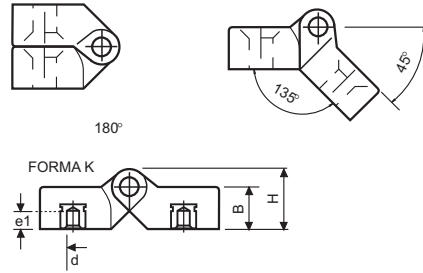

## 470054M BISAGRA PLANA M CON INSERTOS ROSCADOS Y ESPIGAS DE ACERO

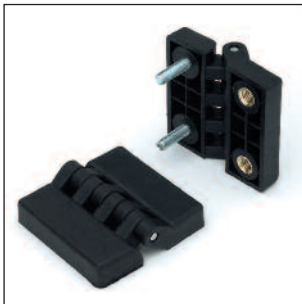

Poliamida reforzada resistente a grasas y aceites. Eje de acero cincado, casquillos de latón y espigas de acero cincado.

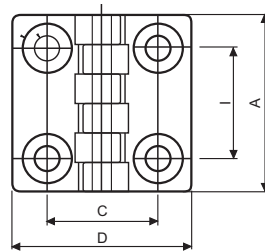

Código	A	D	I	C	H	B	d	e	e1	Color
47005404701	48	48	30	30	15,5	10,5	M5	15	7	Negro
47005406701	64	64	40	40	19	13	M6	20	9	Negro
47005409701	95	95	60	63	28,5	19	M8	20	13	Negro

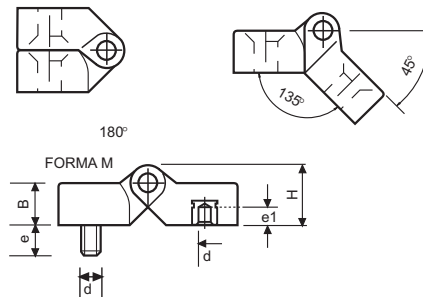

## 470054N BISAGRA PLANA N, INSERTOS ROSCADOS Y TALADROS PASANTES



Poliamida reforzada resistente a grasas y aceites con taladros pasantes. Eje de acero cincado y casquillos de latón.

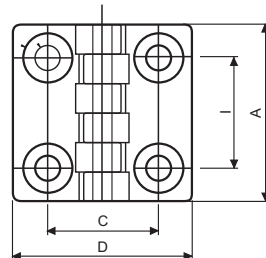

Código	A	D	I	C	H	B	d	d1	e1	Color
47005404402	48	48	30	30	15,5	10,5	M6	6,5	7	Negro
47005406401	64	64	40	40	19	13	M6	6,5	9	Negro

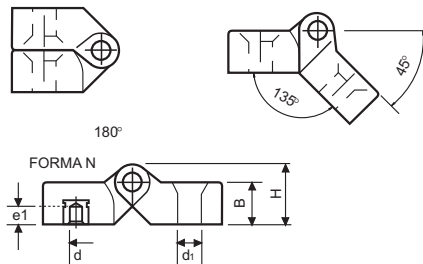

## 470054T BISAGRA PLANA T CON ESPIGAS DE ACERO



Poliamida reforzada resistente a grasas y aceites. Eje de acero cincado y espigas de acero tratado.

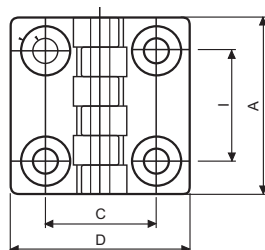

Código	A	D	I	C	H	B	d	e	Color
47005404501	48	48	30	30	15,5	10,5	M5	15	Negro
47005406501	64	64	40	40	19	13	M6	20	Negro
47005409501	95	95	60	63	28,5	19	M8	20	Negro

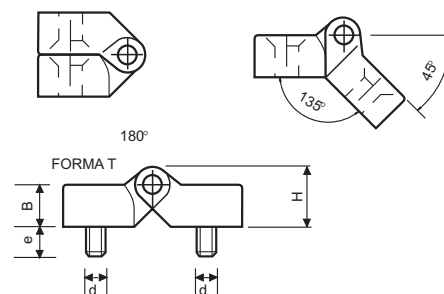

## 470055K BISAGRA HK CON INSERTOS ROSCADOS



Poliamida reforzada resistente a aceites y grasas. Eje de acero cincado y casquillos de latón. Rotación completa: 180°.

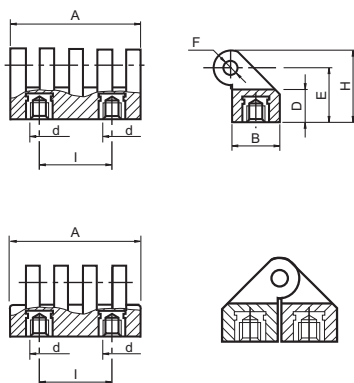

Código	A	D	I	d	E	B	H	F	Color
47005503551	30	11	15	M5	19	17	25	4	Negro
47005505351	54	13	30	M6	22	21	30	5	Negro
47005507351	78	18	42	M8	31	30	42	8	Negro

## 470055K\* BISAGRA HK\* CON INSERTOS ROSCADOS



Poliamida reforzada resistente a aceites y grasas. Eje de acero cincado y casquillos de latón. Rotación completa: 180°.

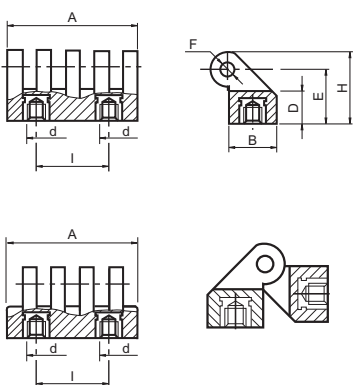

Código	A	D	I	d	E	B	H	F	Color
47005503553	30	11	15	M5	19	17	25	4	Negro
47005505353	54	13	30	M6	22	21	30	5	Negro
47005507353	78	18	42	M8	31	30	42	8	Negro

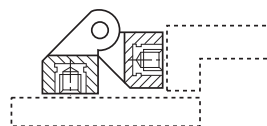

EJEMPLO DE MONTAJE

## 470055T BISAGRA HT CON ESIPIGAS DE ACERO



Poliamida reforzada resistente a aceites y grasas. Eje de acero cincado y espigas de acero tratado. Rotación completa: 180°.

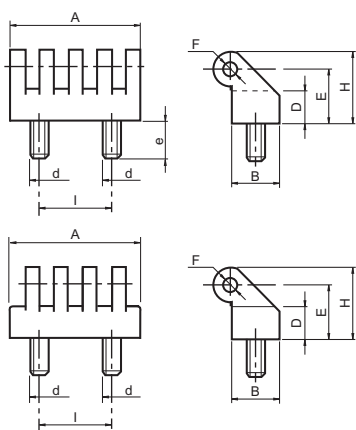

Código	A	D	I	d	e	E	B	H	F	Color
47005503552	30	11	15	M5	10	19	17	25	4	Negro
47005505352	54	13	30	M6	15	22	21	30	5	Negro
47005507352	78	18	42	M8	20	31	30	42	8	Negro

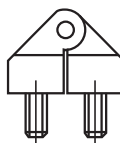

## 470055T\* BISAGRA HT\* CON ESIPIGAS DE ACERO



Poliamida reforzada resistente a aceites y grasas. Eje de acero cincado y espigas de acero tratado. Rotación completa: 180°.

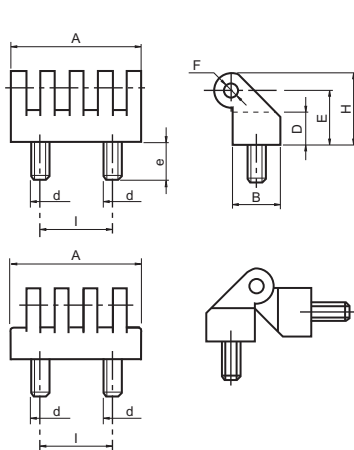

Código	A	D	I	d	e	E	B	H	F	Color
47005503554	30	11	15	M5	10	19	17	25	4	Negro
47005505354	54	13	30	M6	15	22	21	30	5	Negro
47005507354	78	18	42	M8	20	31	30	42	8	Negro

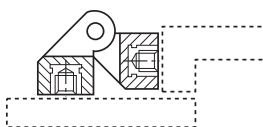

EJEMPLO DE MONTAJE

## 470056 BISAGRA TALADROS PASANTES

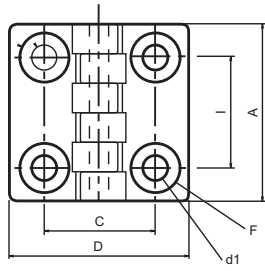
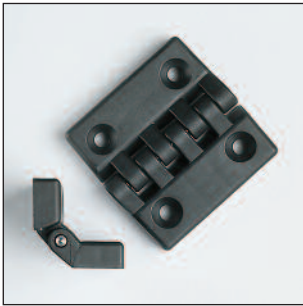

Código	A	D	I	C	d1	B	H	F	Color
47005603050	32	32	20	20	4,5	7	10,5	8	Negro
47005604055	48	48	30	30	6,5	10,5	15,5	13	Negro
47005606056	64	64	40	40	6,5	13	19	13	Negro
47005609050	96	96	60	63	8,5	16	24	16	Negro
47005610050	96	96	60	63	10,5	16	24	20	Negro

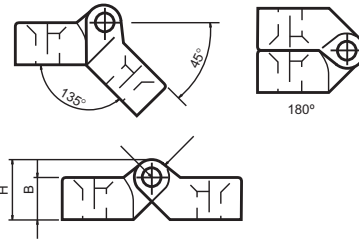

Poliamida reforzada resistente a aceites y grasas. Eje de acero cincado.

## 470056 BISAGRA TALADROS PASANTES, EJE DE ACERO INOXIDABLE

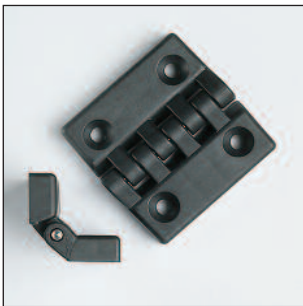

**INOX**  
Acero  
Inoxidable

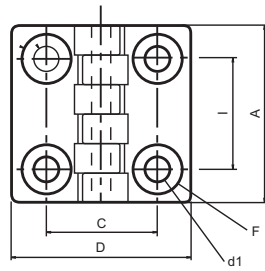

Código	A	D	I	C	d1	B	H	F	Color
47005603150	32	32	20	20	4,5	7	10,5	8	Negro
47005604150	48	48	30	30	6,5	10,5	15,5	13	Negro
47005606150	64	64	40	40	6,5	13	19	13	Negro
47005609150	96	96	60	63	8,5	16	24	16	Negro
47005610150	96	96	60	63	10,5	16	24	20	Negro

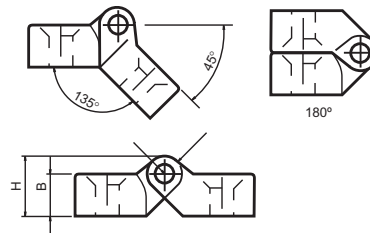

Poliamida reforzada resistente a aceites y grasas. Eje de acero inoxidable.

## 470057 SUPLEMENTO PARA BISAGRA 4756

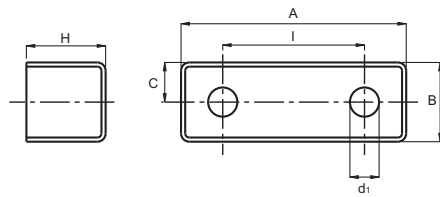
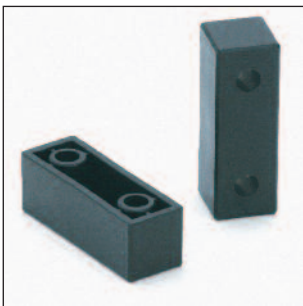

Código	A	I	C	d1	B	H	Color
47005741030	48	30	8	8,5	22	22,5	Negro
47005741140	65	40	11	8,5	22	22,5	Negro

Poliamida reforzada resistente a aceites y grasas.

## 420046 BISAGRA 233 TALADROS PASANTES, EJE DE ACERO INOXIDABLE



Poliamida reforzada resistente a aceites y grasas. Eje de acero inoxidable. Rotación max: 270°.

**INOX**  
Acero  
Inoxidable

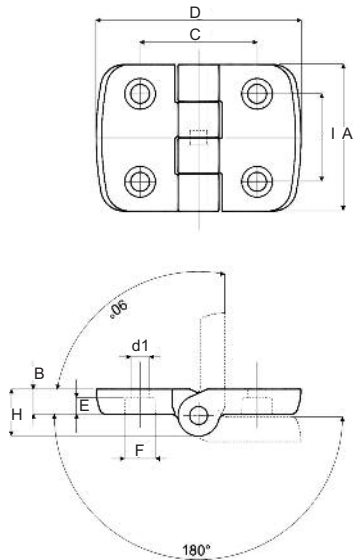

Código	A	D	I	C	d1	F	B	E	H	Color
42004680970	50	50	34	34	5,5	10,5	8,5	3,5	16	Negro
42004680772	50	50	30	31	5,5	9	8,5	5	16	Negro
42004680773	50	70	30	40	6,5	10,5	8,5	6	16	Negro
42004680774	50	70	30	46	6,5	10,5	8,5	6	16	Negro
42004680775	50	70	30	46	8,5	13,5	8,5	5	16	Negro

## 420047 BISAGRA 234 TALADROS PASANTES, EJE DE ACERO INOXIDABLE



Poliamida reforzada resistente a aceites y grasas. Eje de acero inoxidable. Rotación max: 270°.

**INOX**  
Acero  
Inoxidable

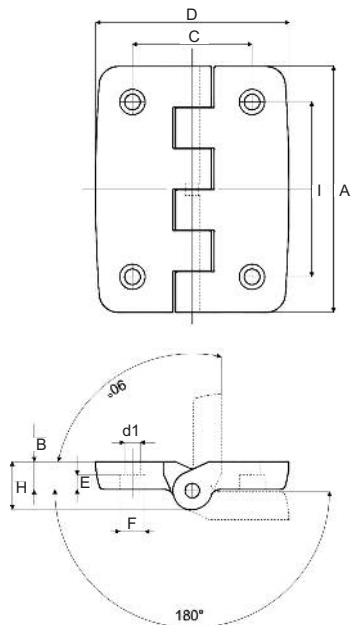

Código	A	D	I	C	d1	F	B	E	H	Color
42004780776	102	80	72,5	49,5	6,5	10,5	11,5	6	20	Negro
42004780777	102	80	72,5	49,5	8,5	13,5	11,5	8	20	Negro

## 470056 BK BISAGRA METÁLICA NEGRA TALADROS PASANTES

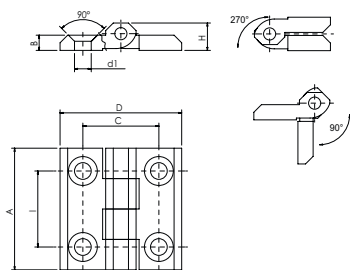

Código	A	D	I	C	d1	B	H	Color
47005604910	40	40	25	25	5,5	5	9	Negro
47005605910	50	50	30	30	6,5	6	11,5	Negro
47005606910	60	60	36	36	6,5	6	11,5	Negro
47005607910	64	64	40	40	6,5	6	11,5	Negro

Aleación ligera.  
Eje de acero inoxidable AISI 303.

## 470056 CR BISAGRA METÁLICA CROMADA TALADROS PASANTES

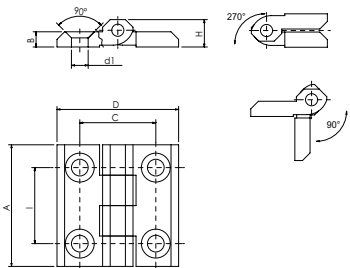

Código	A	D	I	C	d1	B	H	Color
47005604920	40	40	25	25	5,5	5	9	Cromado
47005605920	50	50	30	30	6,5	6	11,5	Cromado
47005606920	60	60	36	36	6,5	6	11,5	Cromado

Aleación ligera cromada.  
Eje de acero inoxidable AISI 303.

## 470056 INOX BISAGRA EN ACERO INOXIDABLE TALADROS PASANTES

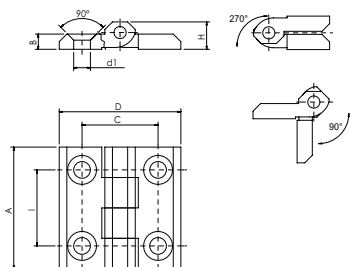

Código	A	D	I	C	d1	B	H	Color
47005604930	40	40	25	25	5,5	5	9	Natural
47005605930	50	50	30	30	8,5	6	11,5	Natural
47005606930	60	60	36	36	8,5	6	11,5	Natural

Acero inoxidable AISI 316.  
Eje de acero inoxidable AISI 303.

**INOX**  
Acero  
Inoxidable