









Tecnodin **Cajoneras**

Pág.		Pág.	
155		157	
155			
155			
155			
156			
156			
156			
156			
157			
157			
157			

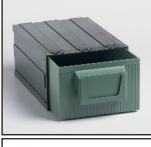
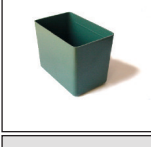
400001 CONTENEDORES APILABLES

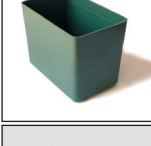

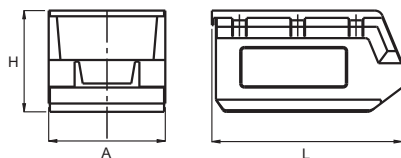
Código	L	A	H	Kg.	Tipo
40000102000	165	103	83	0.081	2
40000103000	240	145	125	0.199	3
40000104000	345	207	165	0.442	4
40000105000	485	303	190	1.018	5

Dimensiones en mm.
Material: Tecnopolymero de color verde resistente a los aceites y disolventes.

400008 PLACA-SOPORTE MURAL TIPO MP 90 PARA CONTENEDORES APILABLES TIPO 2, 3, 4 Y 5

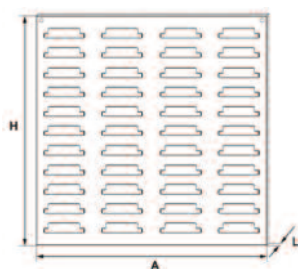
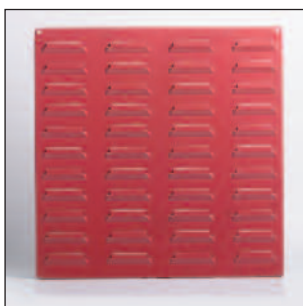

Código	L	A	H
40000800000	15	1000	455

Material: Chapa metálica estampada y pintura de color rojo. (RAL 3002)

400010 CAJONERA L (TRIPLE)

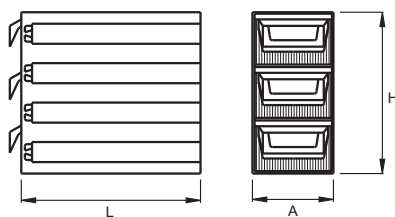

Código	L	A	H
40001000000	250	113	228

Material: Tecnopolymero.
Color: Cajonera negra y cajón verde.
Módulo de 3 cajones, ensamblables lateral y verticalmente con los de su mismo tamaño o con los de ref. 400015 / 400020 / 400021.
El módulo se suministra con 6 separadores de cajón extraíbles (ver ref. 400011).

400011 SEPARADOR CAJÓN TIPO L

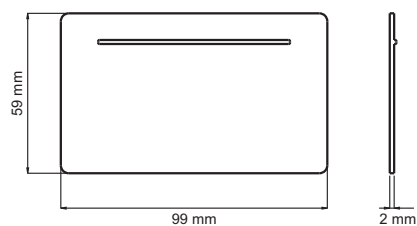

Código	L	A	H
40001100000	2	99	59

Material: Tecnopolymero.
Color: Transparente.

400015 CAJONERA E

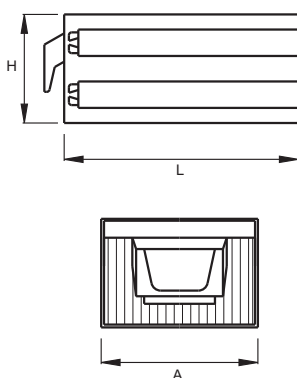
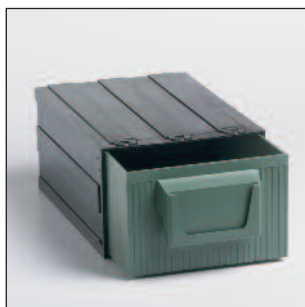

Código	L	A	H
40001500000	250	168	112

Material: Tecnopolymero.
 Color: Cajonera negra y cajón verde.
 El módulo es de un solo cajón, ensamblable lateral y verticalmente con los de su mismo tamaño o con los de ref. 400010 / 400020 / 400021.
 En cada cajón se adaptan perfectamente cuatro cubetas de compartimentación (ref. 400016).

400016 CUBETA COMPARTIMENTACIÓN TIPO E PARA CAJONERA TIPO E

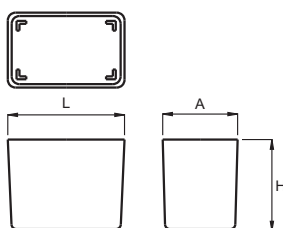
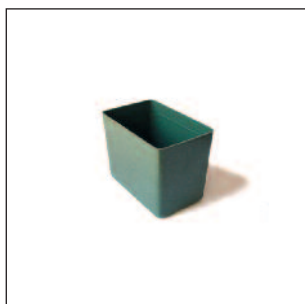

Código	L	A	H
40001600000	117	74	91

Material: Tecnopolymero.
 Color: Verde.

400020 CAJONERA F

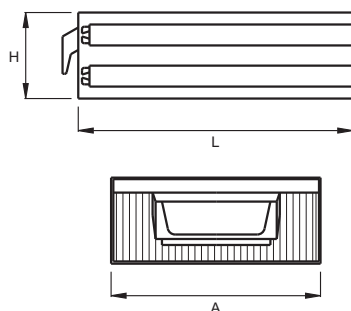
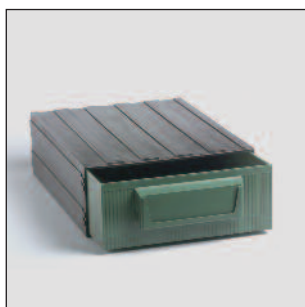

Código	L	A	H
40002000000	372	280	112

Material: Tecnopolymero.
 Color: Cajonera negra y cajón verde.
 El módulo es de un solo cajón, ensamblable lateral y verticalmente con los de su mismo tamaño o con los de ref. 400010 / 400015 / 400021.
 El cajón puede ser dividido por cubetas de compartimentación de distintos tamaños y con la posibilidad de múltiples combinaciones (ref. 400022).

400021 CAJONERA F / T

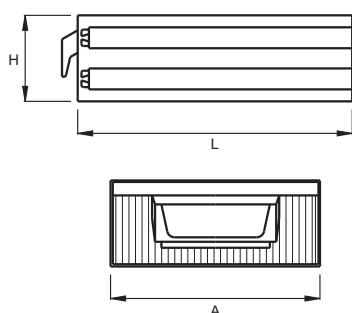

Código	L	A	H
40002100000	366	280	112

Material: Tecnopolymero.
 Color: Cajonera negra y cajón verde.
 El módulo es de un solo cajón, ensamblable lateral y verticalmente con los de su mismo tamaño o con los de ref. 400010 / 400015 / 400020.
 El cajón está dividido longitudinalmente por separador fijo dividiendo el cajón en dos partes de igual tamaño. Cada parte puede a la vez ser dividida por cubetas de compartimentación de distintos tamaños (ref. 400022).

400022 CUBETAS DE COMPARTIMENTACIÓN TIPO F

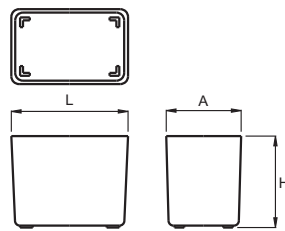

Código	L	A	H	Tipo
40002217000	175	129	91	F1
40002208000	129	86	91	F2
40002204000	129	45	91	F3

Material: Tecnopolymero.
Color: Verde.

400025 MÓDULO VEINTE CAJONES T / 20

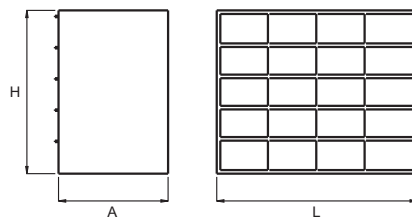

Código	L	A	H
40002500000	279	152	223

Material: Tecnopolymero.
Color bloque: verde y rojo.
Cajones transparentes.
El módulo está compuesto por 20 cajones.
Se suministra con 20 separadores de cajón (ref. 400026).

400026 SEPARADOR CAJONES TIPO T / 20

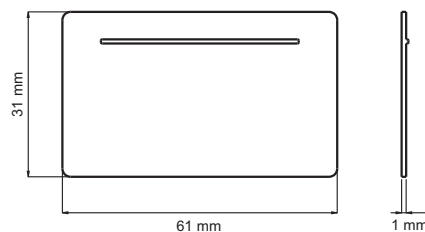

Código	L	A	H
40002600000	1	61	31

Material: Tecnopolymero.
Color: Transparente.

400040 CONTENEDOR PORTATIL MULTIUSO

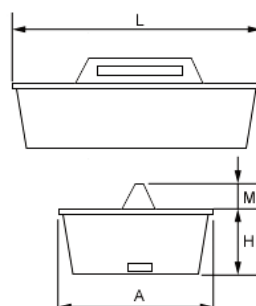

Código	L	A	H	M
40004000000	380	250	107	43

Material: Tecnopolymero.
Color: Naranja.
Apilable.

